

1 Installing the software

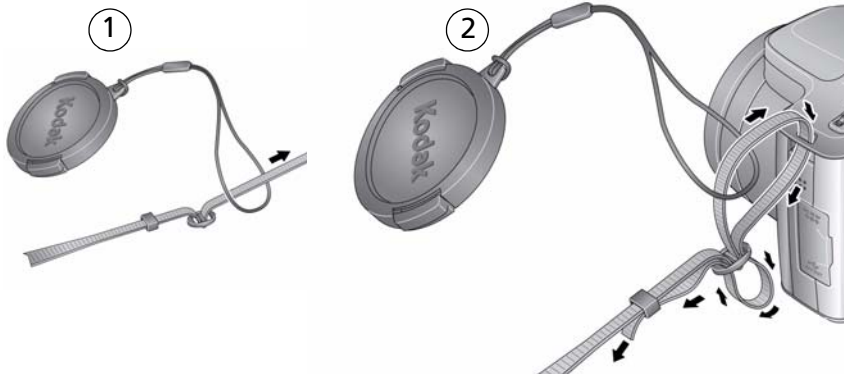

Before connecting any cables, install the software that was included with your camera. Follow the on-screen instructions. After installing the software, return to this user guide.

2 Attaching the strap



See the Extended user guide

www.kodak.com/go/z1015support

3 Loading the battery



Kodak Li-Ion rechargeable digital camera battery KLIC-8000



Kodak lithium digital camera battery CRV3 (non-rechargeable)

See the Extended user guide

www.kodak.com/go/z1015support

Charging the KLIC-8000 battery

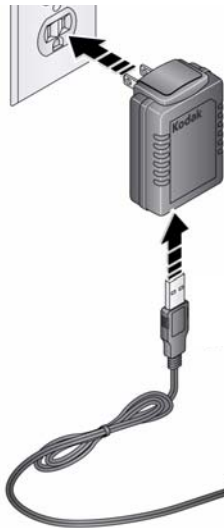

- ① Turn OFF the camera.
- ② Connect the cable.

Note: This charger charges the battery;
it does not power the camera.

Important: DO NOT plug
this cable into a computer.

Charging light

- Blinking: charging
- Steady: finished charging
(approximately 3.5 hours)



See the Extended user guide

www.kodak.com/go/z1015support

Charging the battery using optional accessories

Kodak 5V AC adapter (2 amp)

To charge the battery, turn off the camera.

To power the camera (without charging the battery), turn on the camera.



Kodak EasyShare camera and printer docks

Turn off the camera.



Kodak USB cable and a USB computer port

Turn off the camera. Ensure that the USB cable is connected to a powered USB port and the computer is turned on (not in sleep mode).

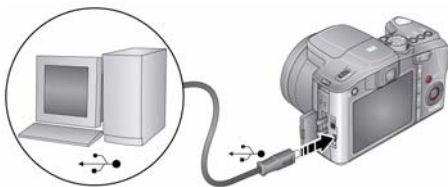

See the Extended user guide

www.kodak.com/go/z1015support

Purchase accessories

www.kodak.com/go/z1015accessories

Learn more about USB charging

www.kodak.com/go/USBcharging

4 Turning on the camera

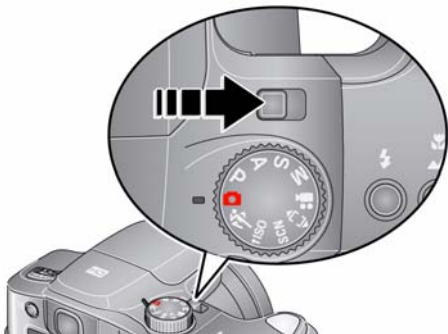

5 Setting the language, date/time

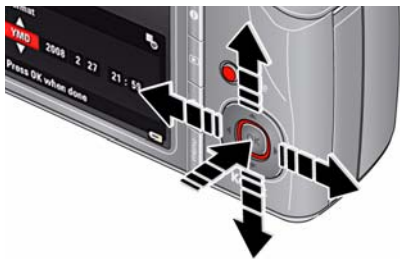

Language:

- ▲/▼ to change
- OK to accept

Date/Time:

- ▲/▼ to change
- ◀/▶ for previous/next field
- OK to accept

See the Extended user guide

www.kodak.com/go/z1015support

6 Taking a picture/video

Pictures

- ① Smart Scene/
Smart Capture
mode

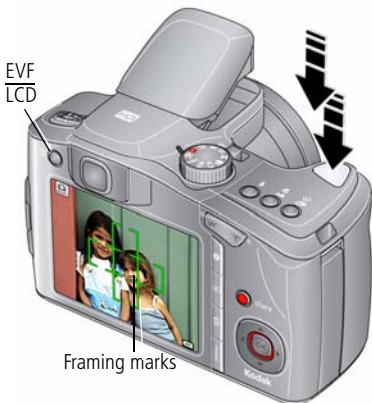

- ② Press the Shutter button halfway to lock the focus. When the framing marks turn green, press the Shutter button completely down.

Videos

- ① Video
mode



- ② Press the Shutter button completely down and release. To stop recording, press and release the Shutter button again.

7 Reviewing pictures/videos

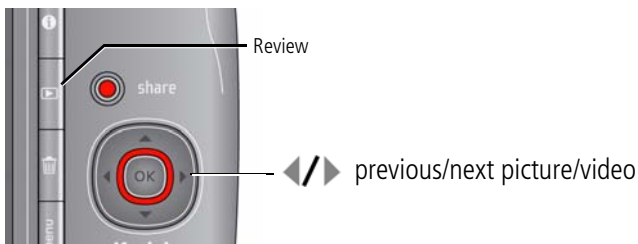

8 Transferring pictures/videos

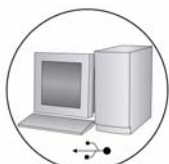

USB cable

- 1 Turn off camera.
- 2 Connect USB cable.
- 3 Turn on camera.



Kodak EasyShare software opens on your computer and prompts you through the transfer process.

Kodak EasyShare printer dock or camera dock

(May be sold separately.)

To use an EasyShare dock, see its user documentation.

See dock compatibility

www.kodak.com/go/dockcompatibility

Purchase accessories

www.kodak.com/go/z1015accessories

9 Keep learning about your camera!

Congratulations!

You have:

- set up your camera
- taken pictures
- transferred pictures to your computer

Keep learning!

Finish reading this book, so you can take and share your best pictures!

Visit www.kodak.com/go/z1015support and www.kodak.com/go/easysharecenter for:

- the extended user guide
- interactive troubleshooting and repairs
- interactive tutorials
- FAQs
- downloads
- accessories
- printing information
- product registration



Learn about on-camera Help [page 23](#)

Front view

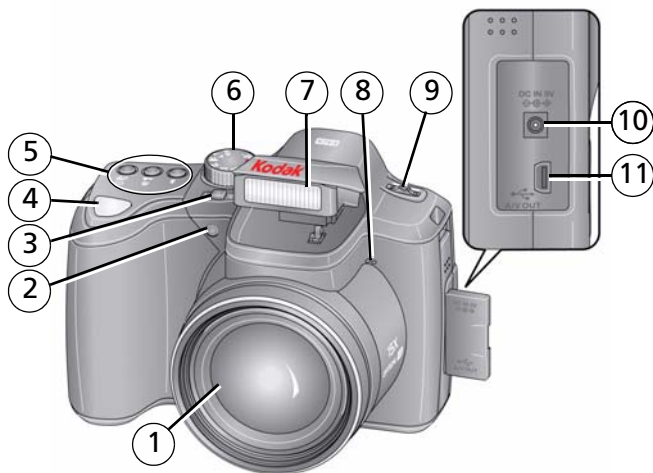

- | | | |
|---|---|--|
| 1 Lens | 4 Shutter button | 7 Flash |
| 2 Low-light assist,
Self-timer light,
Video light | 5 ■ Drive button (Self-timer, Burst)
■ Focus button (Close-up/Macro,
Landscape, Manual)
■ Flash button | 8 Microphone |
| 3 On/Off switch | 6 Mode dial | 9 Jog dial (for PASM modes) |
| | | 10 DC-In (5V), for optional
AC adapter |
| | | 11 USB/AV Out |

Back view

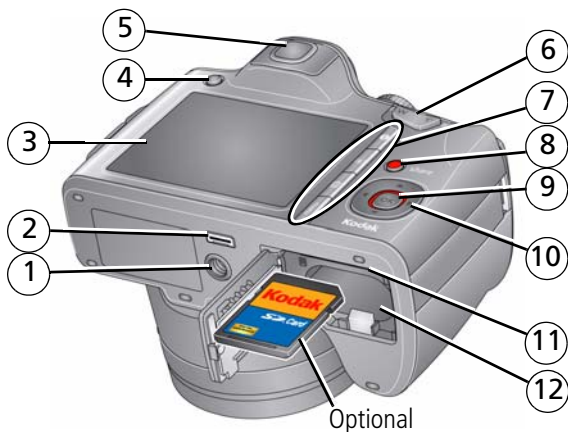





- | | |
|--------------------------------------|-----------------------------------|
| 1 Tripod socket | 7 Info/Review/Delete/Menu buttons |
| 2 Dock connector | 8 Share button |
| 3 LCD | 9 OK button |
| 4 EVF/LCD button | 10 |
| 5 EVF (Electronic viewfinder) | 11 Slot for optional SD/SDHC card |
| 6 Zoom (Wide Angle/Telephoto) button | 12 Battery compartment |

1

Doing more with your camera

Capture modes

Capture mode	For
 Smart Scene/ Smart Capture	<p>General picture taking—it offers excellent image quality and ease of use.</p> <p>NOTE: Smart Scene is the default mode. To change it, press the Menu button, highlight Capture Mode, then press OK. For faster processing, choose Smart Scene. For automatic picture enhancement, choose Smart Capture.</p> <ul style="list-style-type: none"> ■ Faces are detected. ■ The scene is analyzed for other content and for lighting. ■ In Smart Capture, Kodak Perfect Touch technology is applied (for better, brighter pictures). <p>To choose picture size, press the Menu button and choose Picture Size.</p> <ul style="list-style-type: none"> ■ 3:2 (the best choice when making 4 x 6 prints) ■ 16:9 (wide screen) ■ 4:3 (the default setting)
P, A, S, M	More creative control. (See page 21 .) Program, Aperture Priority, Shutter Priority, and Manual mode.
 High ISO	People in low-light scenes.
 Sport	Action pictures.

Capture mode	For
SCN Scene	Point-and-shoot simplicity when taking pictures under special conditions.
 Panorama	"Stitching" 2 or 3 pictures into 1 panoramic scene.
 Video	Video with sound. (See page 6 .)

Using the 15X optical zoom

Use optical zoom to get up to 15X closer to your subject while taking pictures/videos.

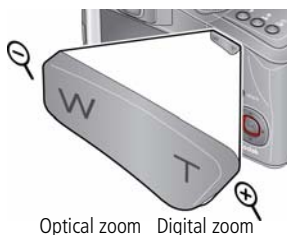

- 1 Use the LCD to frame your subject.
- 2 Press Telephoto (T) or Wide (W) to zoom in/out.
- 3 Take the picture or video.

NOTE: To get a focused picture every time, remember:

- Use the auto focus framing marks, [page 6](#).
- As you zoom in, move away from your subject.

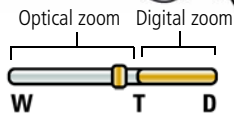





Use digital zoom to get up to 5X beyond optical zoom while taking pictures. Press Telephoto (T) past the maximum optical zoom. Digital zoom is not available in Smart Scene/Smart Capture mode.

NOTE: You may notice decreased image quality when using digital zoom. The slider on the zoom indicator turns red when the picture quality reaches the limit for an acceptable 4 x 6-in. (10 x 15 cm) print.

Using the flash



Press repeatedly to scroll through flash modes.
(See flash modes below.)



Flash modes	Flash fires
Auto	 When the lighting conditions require it.
Off	 Never.
Fill	 Every time you take a picture. Use when the subject is in shadow or is “backlit.” In low light, hold the camera steady or use a tripod. Not available in Smart Scene/Smart Capture mode. (ISO is set to 400.)
Red Eye Your camera can correct red-eye using 2 methods	 Preflash —A preflash fires, shrinking the eye pupil, before the picture is taken.
	 Digital Correction —A preflash does not fire; the camera corrects red eye.







Flash-to-subject distance in Smart Scene/Smart Capture mode

Wide angle	5.0 m (16.4 ft)
Telephoto	3.2 m (10.5 ft)

Using focus modes





- 1 In most Still modes, press the Focus / button:
 - Once for Macro (close-up)
 - Again for Landscape (infinity)
 - Again for Manual Focus
 - Again to return to normal Auto Focus
- 2 Compose the scene. Press the Shutter button **halfway**, then completely down.

Icon	Mode	Description
(none)	Normal AF	Focus setting for general picture-taking.
	Macro	To gain sharpness and detail in pictures at close range. Use available light instead of flash, if possible. Camera automatically sets the focus distance depending on the zoom position: 0.1–1.0 m (0.3–3.3 ft) @ wide macro 0.7–3.5 m (2.3–11.5 ft) @ telephoto macro
	Landscape	To gain sharpness of distant scenes. Camera uses infinity auto-focus. Auto-focus framing marks are not available in Landscape.
MF	Manual Focus	The focus icon shows the direction and distance of the focus (to infinity). Press  /  to view 2X magnification of the central area of focus. During magnification, press  /  to adjust focal length. (Framing marks are off in this mode.)

Using the self-timer

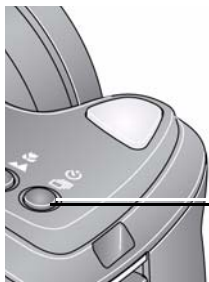
Use the self-timer when you want to be included in a picture, or to ensure a steady Shutter button press.



- 1 Place the camera on a tripod or flat surface.
- 2 In most Still modes, press the Self-timer/Burst button :
 - Once for a 10-second delay (so you have time to get into the scene)
 - Again for a 2-second delay (for a steady, auto-shutter release on a tripod)
 - Again for 2-shot (one picture taken after 10 seconds; another, 8 seconds later)

- 3 Compose the scene. Press the Shutter button **halfway**, then **completely down**.

The picture is taken after the delay.

To cancel the Self-timer during countdown, press the Self-timer/Burst button , or press the Shutter button completely down.

Use the same procedure to use the self-timer in Video mode, but:

- Turn the Mode dial to Video .
- Press the Shutter button completely down.

NOTE: The video stops when no storage space remains. Only the 2- and 10-second options are available in video mode.

Using the burst feature

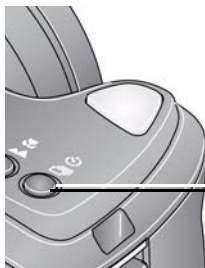

- 1 In most Still modes, press the Self-timer/Burst button . (See burst modes below.)



NOTE: Burst is unavailable in Portrait, Night Portrait, Night Landscape, Backlight, Fireworks, and Panorama modes.

- 2 Press the Shutter button **halfway** to focus and set exposure.

- 3 Press the Shutter button **completely down and hold it** to take pictures.

The camera stops taking pictures when you release the Shutter button, when the pictures are taken, or when there is no more storage space.

NOTE: During quickview, you can delete all pictures in the burst series. To delete selectively, do so in Review (see [page 18](#)).

Mode	Icon	Description	Purpose
First Burst		Camera takes up to 3 pictures while the Shutter button is pressed.	Capture an expected event. Example: A person swinging a golf club.
Last Burst		Camera takes up to 30 pictures while the Shutter button is pressed. When the Shutter button is released, only the last 3 pictures are saved.	Capture an event when the precise timing is uncertain. Example: A child blowing out birthday candles.

Understanding the picture-taking icons

Status icons indicate mode, feature, and camera status.

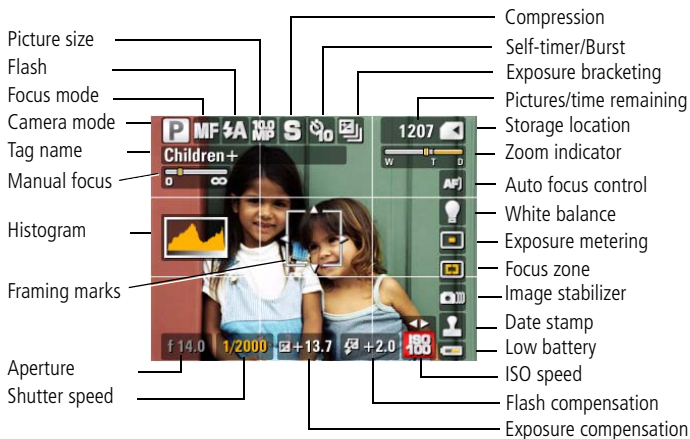

2

Working with pictures/videos

Deleting pictures/videos



- 1 Press the Review button.
- 2 Press ◀/▶ to find a picture/video.
- 3 Press the Delete button.
- 4 Follow the screen prompts.

Using the menu button in Review

- 1 Press the Review button, then the Menu button.
- 2 Press ◀/▶ to choose a tab:
 - **Review** to view pictures/videos
 - **Edit** to edit pictures/videos
 - **Setup** for other camera settings
- 3 Press ▲/▼ to highlight a setting, then press OK.
- 4 Choose an option, then press OK.

IMPORTANT: Your camera offers an on-board Help system. To get the most from your camera, see [page 23](#).

Understanding the review icons

Pictures





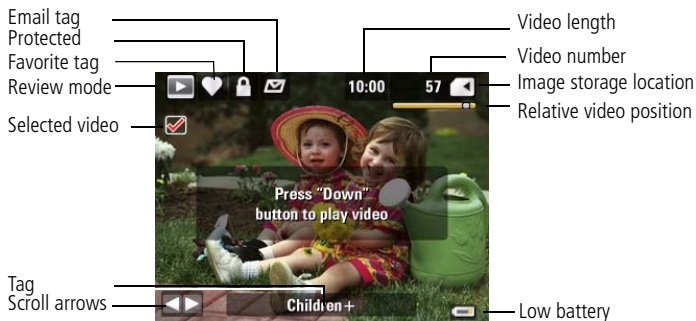

Videos



3 Using the advanced features

Using the Menu button to change settings

NOTE: Some settings remain until you change them; others remain until you turn off the camera. Some capture modes offer limited settings.

- 1 Press the Menu button.
- 2 Press   to highlight a menu tab:
 - **Capture** for the most common picture-taking settings.
 - **Capture +** for more advanced picture-taking settings.
 - **Setup** for other camera settings.
- 3 Press   to highlight a setting, then press OK.
- 4 Choose an option, then press OK.

NOTE: Press the Info button  for information about camera settings and options. Some capture modes offer limited settings.

P, A, S, and M modes

Use these modes when you want more control over your camera and pictures.

Mode	When to use	Press Jog dial to control
P	Program mode offers the ease of auto shooting with full access to all menu options. The camera sets the shutter speed and aperture (f-stop) based on the scene lighting.	Exposure compensation, flash compensation, and ISO speed
A	Aperture Priority mode controls depth of field (the range of sharpness). The aperture setting may be affected by optical zoom.	Aperture, exposure compensation, flash compensation, and ISO speed
S	Shutter Priority mode prevents blur when your subject is moving. The camera automatically sets the aperture for proper exposure. (Use a tripod for slow shutter speeds.)	Shutter speed, exposure compensation, and flash compensation
M	Manual mode offers the highest level of creative control. (To prevent blur, use a tripod for slow shutter speeds.)	Aperture, shutter speed, flash compensation, and ISO speed

Jog dial:

- 1 Turn to access a setting.
- 2 Press to unlock the setting.
- 3 Turn to change the setting.
- 4 Press to lock the setting.

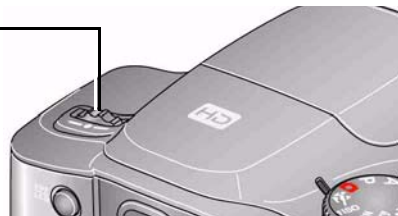

NOTE: Settings you change in P, A, S, or M modes apply only to pictures taken in those modes. The settings, including Flash, are maintained for P, A, S, and M modes—even when you change modes or turn off the camera. Use Reset Camera to reset P, A, S, or M mode to its default setting.

Changing P, A, S, or M mode settings

PASM modes control the aperture, shutter speed, exposure compensation, flash compensation, and ISO. Use the Menu button to control all other settings.

- 1 Turn the Mode dial to P, A, S, or M.
- 2 Jog dial: Turn to access a setting. Press to unlock the setting. Turn to change the setting. Press to lock the setting. (See [page 21](#).)

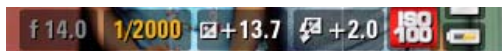

Note: A yellow setting indicates possible unsatisfactory results. (However, you can still take the picture.)

ISO
Flash compensation
Exposure compensation
Shutter speed
Aperture

ISO—adjust the camera’s sensitivity to light. Higher ISO indicates greater sensitivity.

NOTE: A higher ISO may produce unwanted “noise” in a picture. ISO 3200 and 6400 available only in 3.1 MP and lower picture sizes.

Flash Compensation—adjust flash brightness.

Exposure Compensation—adjust the exposure (lighten or darken pictures).

Shutter speed—control how long the shutter stays open.

Aperture—(also known as f-stop) control the size of the lens opening, depth of field.

- Smaller f-stop numbers indicate a larger lens opening; good for low-light.
- Larger f-stop numbers indicate a smaller lens opening; keeps the main subject sharp; good for landscapes and well-lit conditions.

4

Solving camera problems

Getting help from your camera

Your camera offers a built-in Help system. It describes every setting for every menu choice. If you learn nothing else about your camera, learn how to use on-camera Help. Because the more you know your camera, the more confident you become!

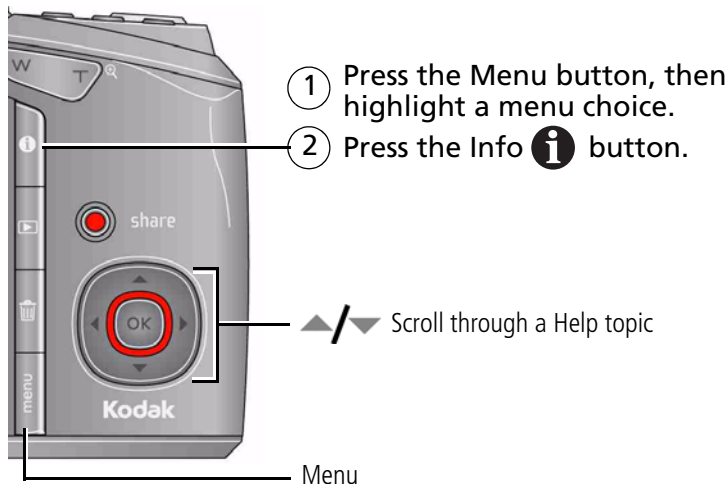

For step-by-step product support, visit www.kodak.com/go/z1015support and select Interactive Troubleshooting & Repairs.

www.kodak.com/go/z1015support

5 Appendix



CAUTION:

Do not disassemble this product; there are no user-serviceable parts inside. Refer servicing to qualified service personnel. Kodak AC adapters and battery chargers are intended for indoor use only. The use of controls, adjustments, or procedures other than those specified herein may result in exposure to shock and/or electrical or mechanical hazards. If the LCD breaks, do not touch the glass or liquid. Contact Kodak customer support.

- The use of an accessory that is not recommended by Kodak may cause fire, electric shock, or injury. For approved accessories, visit www.kodak.com/go/accessories.
- Use only a USB-certified computer equipped with a current-limiting motherboard. Contact your computer manufacturer if you have questions.
- If using this product in an airplane, observe all instructions of the airline.
- When removing the battery, allow it to cool; it may be hot.
- Follow all warnings and instructions supplied by the battery manufacturer.
- Use only batteries approved for this product to avoid risk of explosion.
- Keep batteries out of the reach of children.
- Do not allow batteries to touch metal objects, including coins. Otherwise, a battery may short circuit, discharge energy, become hot, or leak.
- Do not disassemble, install backward, or expose batteries to liquid, moisture, fire, or extreme temperature.
- Remove the battery when the product is stored for an extended period of time. In the unlikely event that battery fluid leaks inside the product, contact Kodak customer support.
- In the unlikely event that battery fluid leaks onto your skin, wash immediately with water and contact your local health provider. For additional health-related information, contact your local Kodak customer support.
- Dispose of batteries according to local and national regulations. Visit www.kodak.com/go/kes.
- Do not charge non-rechargeable batteries.

For more information on batteries, see www.kodak.com/go/batterytypes.

Limited Warranty

Kodak warrants Kodak consumer electronic products and accessories (“Products”), excluding batteries, to be free from malfunctions and defects in both materials and workmanship for one year from the date of purchase. Retain the original dated sales receipt. Proof of the date of purchase will be required with any request for warranty repair.

Limited warranty coverage

Warranty service is only available from within the country where the Products were originally purchased. You may be required to ship Products, at your expense, to the authorized service facility for the country where the Products were purchased. Kodak will repair or replace Products if they fail to function properly during the warranty period, subject to any conditions and/or limitations stated herein. Warranty service will include all labor as well as any necessary adjustments and/or replacement parts. If Kodak is unable to repair or replace a Product, Kodak will, at its option, refund the purchase price paid for the Product provided the Product has been returned to Kodak along with proof of the purchase price paid. Repair, replacement, or refund of the purchase price are the sole remedies under the warranty. If replacement parts are used in making repairs, those parts may be remanufactured, or may contain remanufactured materials. If it is necessary to replace the entire Product, it may be replaced with a remanufactured Product. Remanufactured Products, parts and materials are warranted for the remaining warranty term of the original Product, or 90 days after the date of repair or replacement, whichever is longer.

Limitations

This warranty does not cover circumstances beyond Kodak’s control. This warranty does not apply when failure is due to shipping damage, accident, alteration, modification, unauthorized service, misuse, abuse, use with incompatible accessories or attachments (such as third party ink or ink tanks), failure to follow Kodak’s operation, maintenance or repacking instructions, failure to use items supplied by Kodak (such as adapters and cables), or claims made after the duration of this warranty. **Kodak makes no other express or implied warranty for this product, and disclaims the implied warranties of merchantability and fitness for a particular purpose.** In the event that the exclusion of any implied warranty is ineffective under the law, the duration of the implied warranty will be one year from the purchase date or such longer period as required by law. The option of repair, replacement, or refund is Kodak’s only obligation. Kodak will not be responsible for any special, consequential or incidental damages resulting from the sale, purchase, or use of this product regardless of the cause. Liability for any special, consequential or incidental damages (including but not limited to loss of revenue or profit, downtime costs, loss of the use of the equipment, cost of substitute equipment,

facilities or services, or claims of your customers for such damages resulting from the purchase, use, or failure of the Product), regardless of cause or for breach of any written or implied warranty is expressly disclaimed.

Your rights

Some states or jurisdictions do not allow exclusion or limitation of incidental or consequential damages, so the above limitation or exclusion may not apply to you. Some states or jurisdictions do not allow limitations on how long an implied warranty lasts, so the above limitation may not apply to you. This warranty gives you specific rights, and you may have other rights which vary from state to state or by jurisdiction.

Outside the United States and Canada

In countries other than the United States and Canada, the terms and conditions of this warranty may be different. Unless a specific Kodak warranty is communicated to the purchaser in writing by a Kodak company, no warranty or liability exists beyond any minimum requirements imposed by law, even though defect, damage, or loss may be by negligence or other act.

Regulatory compliance

FCC compliance and advisory

 Kodak EasyShare Z1015 IS digital camera

This equipment has been tested and found to comply with the limits for a Class B digital device, pursuant to Part 15 of the FCC Rules. These limits are designed to provide reasonable protection against harmful interference in a residential installation. This equipment generates, uses, and can radiate radio frequency energy and, if not installed or used in accordance with the instructions, may cause harmful interference to radio communications. However, there is no guarantee that interference will not occur in a particular installation. If this equipment does cause harmful interference to radio or television reception, which can be determined by turning the equipment off and on, the user is encouraged to try to correct the interference by one or more of the following measures: 1) reorient or relocate the receiving antenna; 2) increase the separation between the equipment and the receiver; 3) connect the equipment to an outlet on a circuit different from that to which the receiver is connected; 4) consult the dealer or an experienced radio/TV technician for additional suggestions. Any changes or modifications not expressly approved by the party responsible for compliance could void the user's authority to operate the equipment. Where shielded interface cables have been provided with the

product or specified additional components or accessories elsewhere defined to be used with the installation of the product, they must be used in order to ensure compliance with FCC regulation.

Australian C-Tick



Waste Electrical and Electronic Equipment labeling



EU: It is the final user's responsibility to discard this equipment into an approved, segregated collection scheme to enable its suitable treatment/disposal and to improve human/environmental protection. For more information, see your retailer, local authority, or www.kodak.com/go/recycle. (Product weight: 325 g.)

Canadian DOC statement

DOC Class B Compliance—This Class B digital apparatus complies with Canadian ICES-003.

Observation des normes-Classe B—Cet appareil numérique de la classe B est conforme à la norme NMB-003 du Canada.

FCC and Industry Canada

This device complies with Industry Canada RSS-210 and FCC Rules. Operation is subject to the following two conditions: (1) this device may not cause harmful interference, and (2) this device must accept any interference received, including interference that may cause undesired operation.

FCC et Industrie Canada

Cet appareil est conforme à la norme RSS-210 d'Industrie Canada et aux réglementations de la FCC. Son utilisation est soumise aux deux conditions suivantes : (1) cet appareil ne doit pas provoquer d'interférences nuisibles, et (2) cet appareil doit supporter les interférences reçues, y compris celles susceptibles de nuire à son bon fonctionnement.

VCCI Class B ITE

この装置は、情報処理装置等電波障害自主規制協議会（VCCI）の基準に基づきクラスB情報技術装置です。この装置は、家庭環境で使用することを目的としていますが、この装置がラジオやテレビジョン受信機に近接して使用されると、受信障害を引き起こすことがあります。取扱説明書に従って正しい取り扱いをして下さい。

Korean Class B ITE

이 기기는 가정용으로 전자파적합등록을 한 기기로서 주거지역에서는 물론 모든 지역에서 사용할 수 있습니다.

TUV certification

Contact:

Kodak GmbH

Hedelfingerstrasse 60

70327 Stuttgart

Telephone: 069 500 700 35

MPEG-4

Use of this product in any manner that complies with the MPEG-4 visual standard is prohibited, except for use by a consumer engaging in personal and non-commercial activities.

Russian GOST-R



Eastman Kodak Company
Rochester, NY 14650

AIO-40

Фотокамера изготовлена в Китае; остальные элементы -
в соответствии с маркировкой.

China RoHS

环保使用期限 (EPUP)

在中国大陆, 该值表示产品中存在的任何危险物质不得释放, 以免危及人身健康、财产或环境的时间期限(以年计)。该值根据操作说明中所规定的产品正常使用而定。

有毒有害物质或元素名称及含量标识表

部件名称	有毒有害物质或元素					
	铅	汞	镉	六价铬	多溴联苯	多溴二苯醚
数码相机电路板元件	×	○	○	○	○	○
锂电池	×	○	○	○	○	○
交流变压器	×	○	○	○	○	○

○: 表示该有毒有害物质在该部件所有均质材料中的含量均在SJ/T 11363-2006规定的限量要求以下。
×: 表示该有毒有害物质至少在该部件的某一均质材料中的含量超出SJ/T 11363-2006规定的限量要求。



USB 数据线

Kodak

Eastman Kodak Company

Rochester, New York 14650

© Eastman Kodak Company, 2008

Kodak, EasyShare, and Perfect Touch are trademarks of Eastman Kodak Company.

4F8330_en

www.kodak.com/gol/z1015support